

HS側溝

(例250×250)

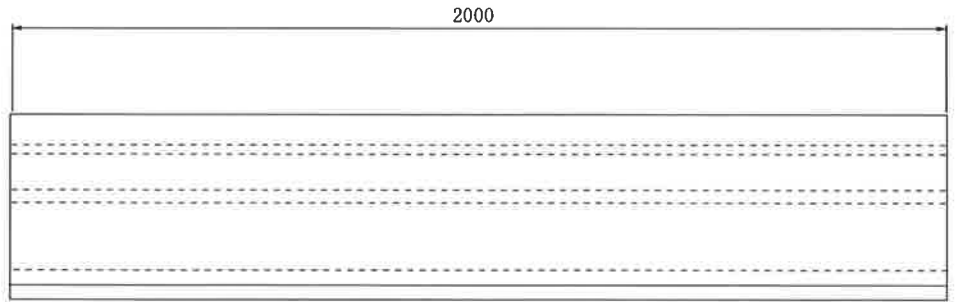
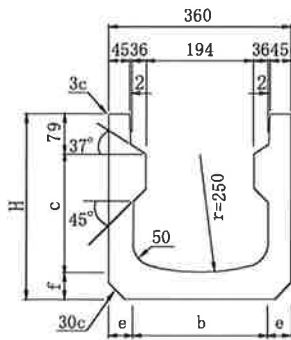

単位：mm

種類	呼び	寸法
----	----	----

		b	C	e	f	r	ℓ	H	参考重量
250	250×250	250	251	55	65	50	2000	395	320
	250×300	250	301	55	65	50	2000	445	345
	250×400	240	401	60	65	50	2000	545	405
	250×500	230	501	65	65	50	2000	645	468
	250×600	220	601	70	75	50	2000	755	553
	250×700	200	701	80	80	50	2000	860	649
寸法の許容差		±3				±6			

250用ふた 参考重量26kg

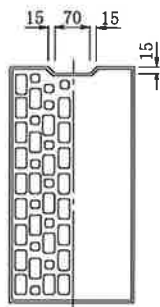
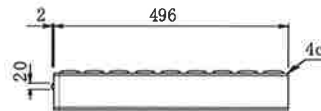
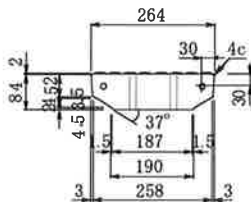

株式会社 林 建材

HS側溝 (ボルト固定)

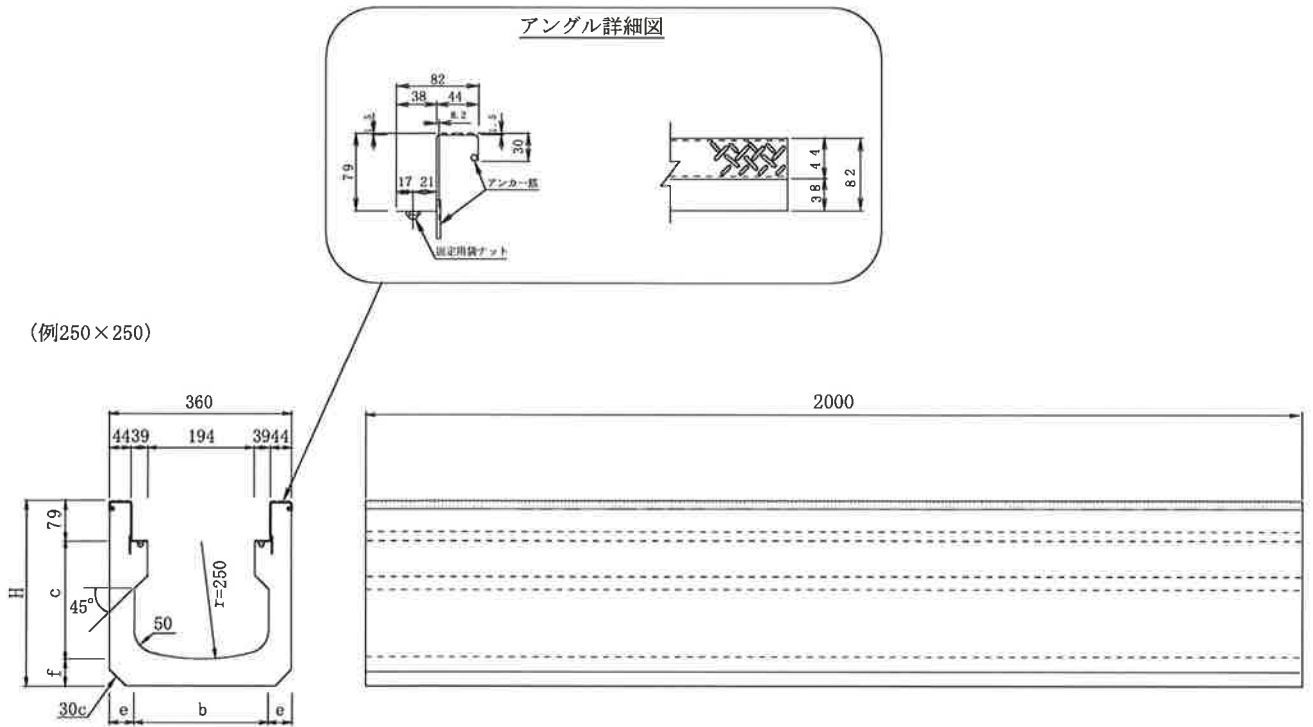

単位：mm

種類	呼び	寸法							参考重量
		b	C	e	f	r	ℓ	H	
250	250×250	250	251	55	65	50	2000	395	320
	250×300	250	301	55	65	50	2000	445	345
	250×400	240	401	60	65	50	2000	545	405
	250×500	230	501	65	65	50	2000	645	468
	250×600	220	601	70	75	50	2000	755	553
	250×700	220	701	80	80	50	2000	860	649
寸法の許容差		±3					±6		

HS側溝

(例300×300)

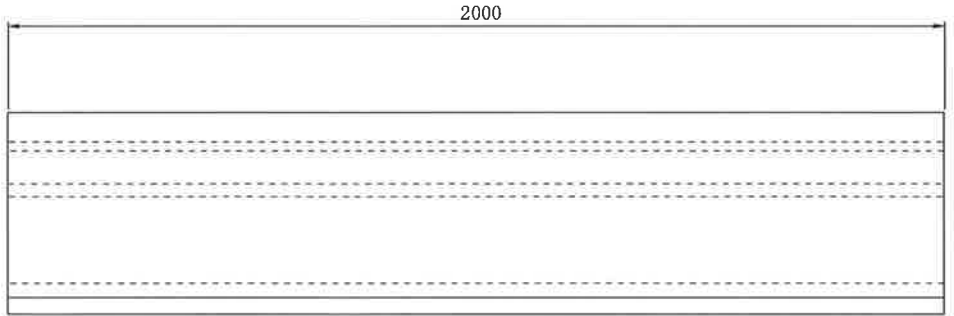
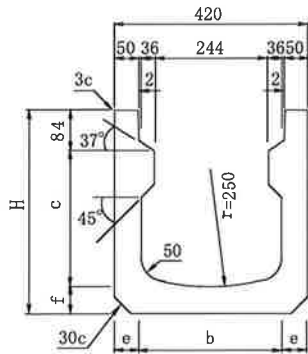

単位：mm

種類	呼び	寸法							参考重量
		b	C	e	f	r	ℓ	H	
300	300×300	300	301	60	70	50	2000	455	404
	300×400	300	401	60	70	50	2000	555	462
	300×500	280	501	70	85	50	2000	670	565
	300×600	280	601	70	85	50	2000	770	627
	300×700	260	701	80	85	50	2000	870	715
	300×800	250	801	85	90	50	2000	975	807
寸法の許容差		±3					±6		

300用ふた

参考重量32kg

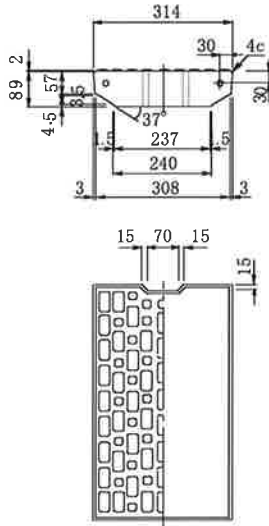

300用スリット付ふた

参考重量28kg

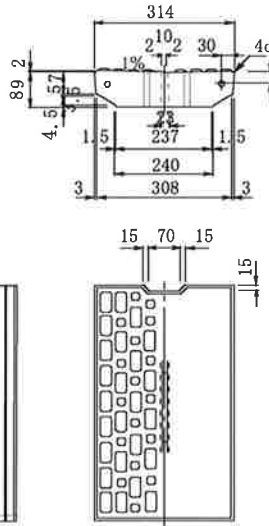

HS側溝 (ボルト固定)

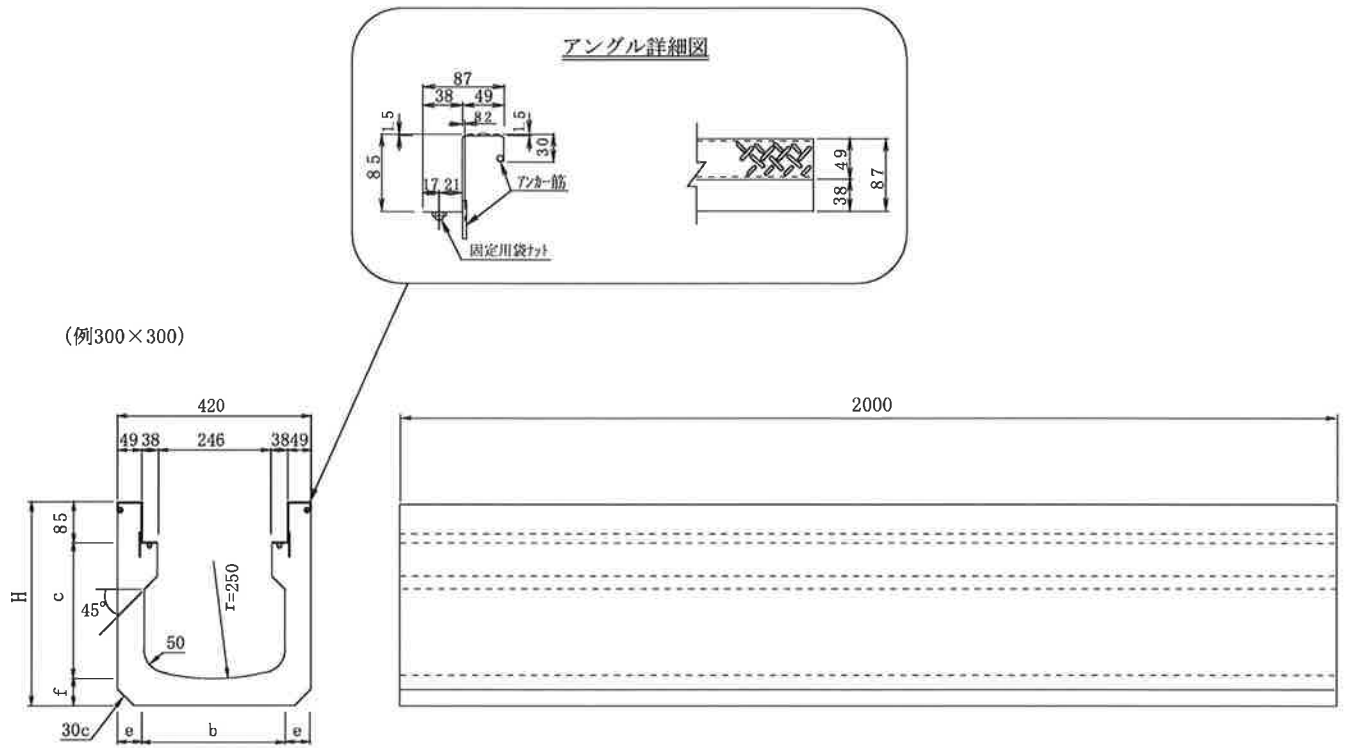

(例300×300)

単位：mm

種類	呼び	寸法							参考重量
		b	C	e	f	r	ℓ	H	
300	300×300	300	301	60	70	50	2000	455	404
	300×400	300	401	60	70	50	2000	555	462
	300×500	280	501	70	85	50	2000	670	565
	300×600	280	601	70	85	50	2000	770	627
	300×700	260	701	80	85	50	2000	870	715
	300×800	250	801	85	90	50	2000	975	807
寸法の許容差		±3				±6			

HS側溝400用

(例400×400)

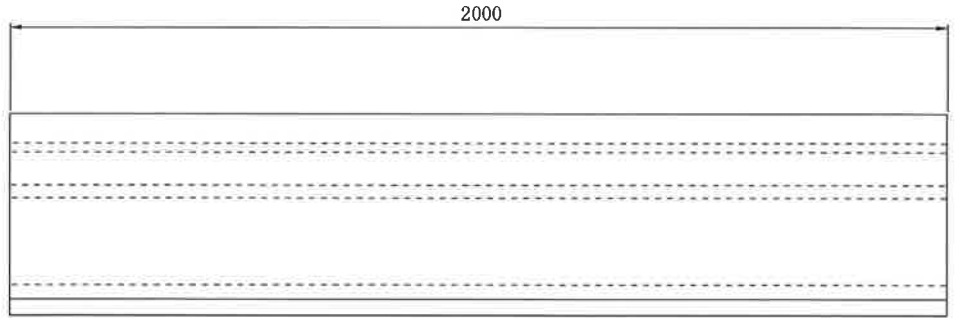
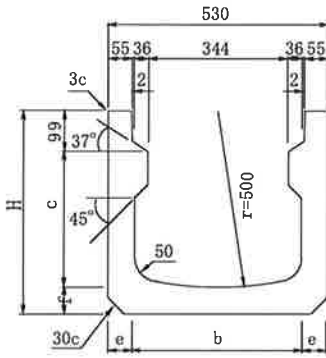

単位：mm

種類	呼び	寸法							参考重量
		b	C	e	f	r	ℓ	H	
400	400×400	400	401	65	70	50	2000	570	538
	400×500	390	501	70	75	50	2000	675	620
	400×600	380	601	75	80	50	2000	780	708
寸法の許容差		±3					±6		

400用ふた 参考重量50kg

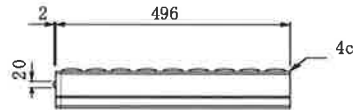
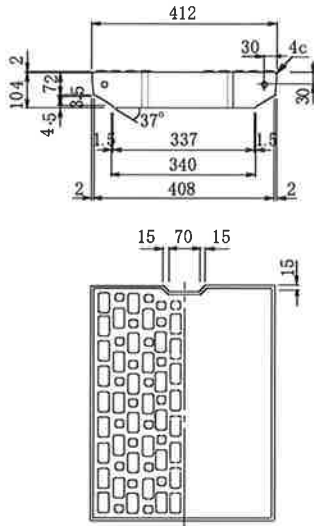

HS側溝400用 (ボルト固定)

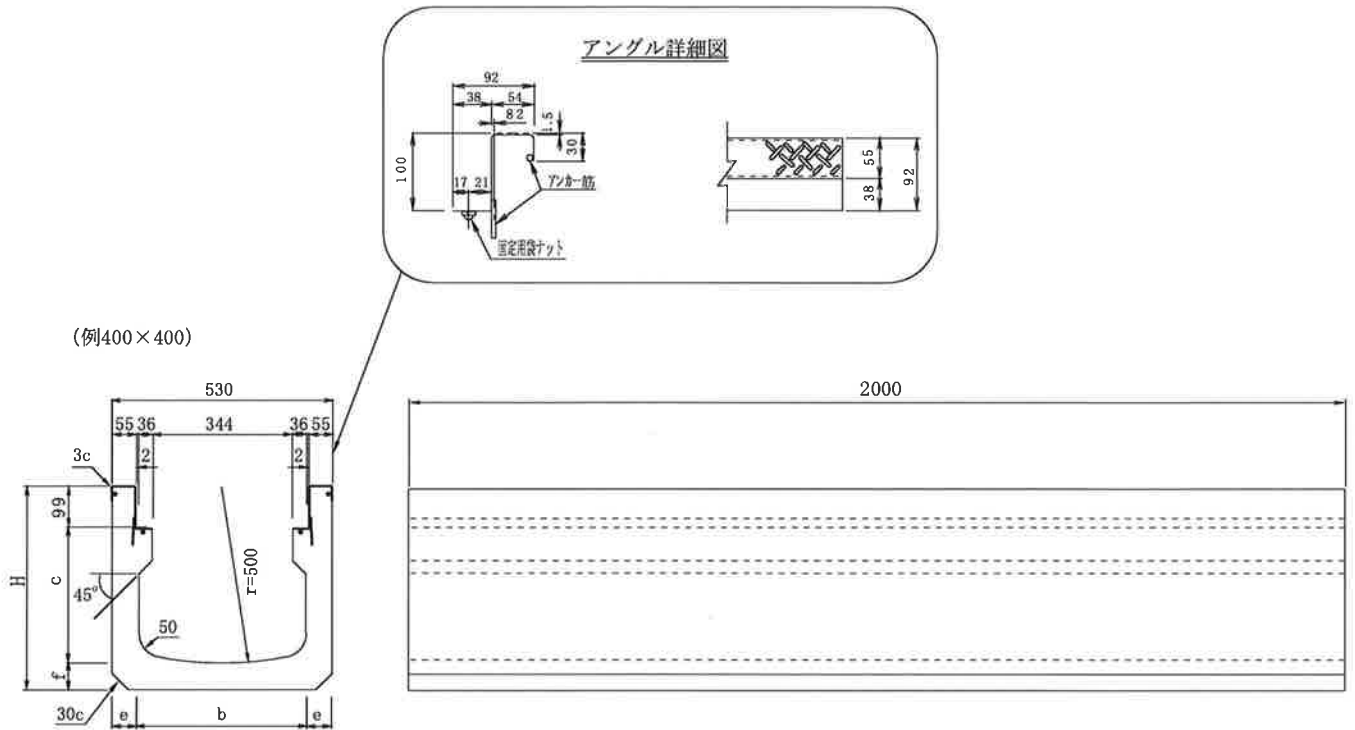

単位：mm

種類	呼び	寸法							参考重量
		b	C	e	f	r	ℓ	H	
400	400×400	400	401	65	70	50	2000	570	538
	400×500	390	501	70	75	50	2000	675	620
	400×600	380	601	75	80	50	2000	780	708
寸法の許容差		±3					±6		

HS側溝用 集水ふた

250用集水ふた 参考重量26kg

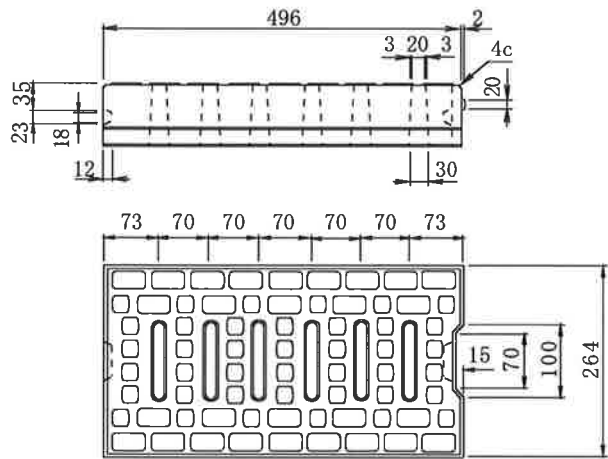
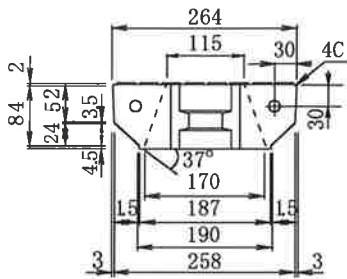

2

300用集水ふた 参考重量32kg

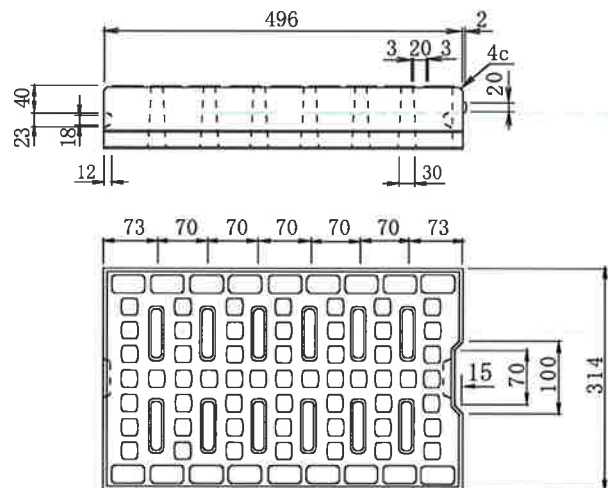
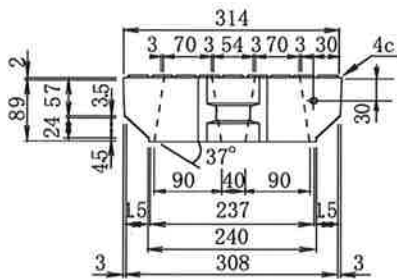

HS側溝400用 集水ふた

400用集水ふた

