

HS 可変勾配側溝

図 300×300

正面図

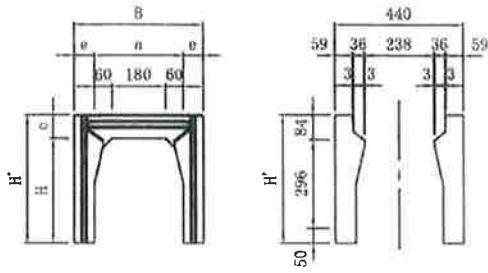

平面図

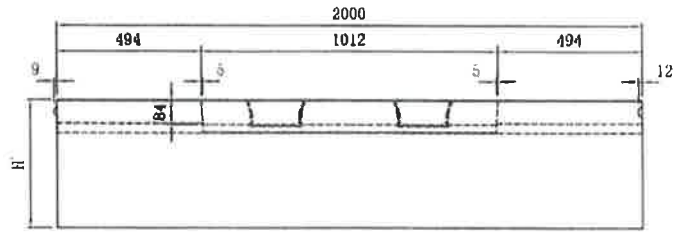

側面図

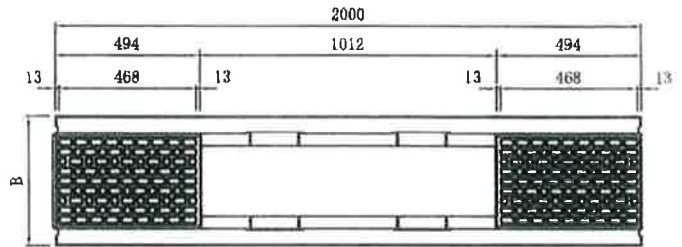

呼び	寸法 (mm)							参考重量
	B	H'	a	H	e	c	L	
300×300	440	430	300	350	70	80	2000	371
400		530		450				439
500		630		550				506
600		730		650				573
700		830		750				640
800		930		850				707
900		1030		950				775
1000		1130		1050				842
1100		1230		1150				909
1200		1330		1250				975

HS可変勾配側溝

(L=1500・1000)

例 300×300

正面図

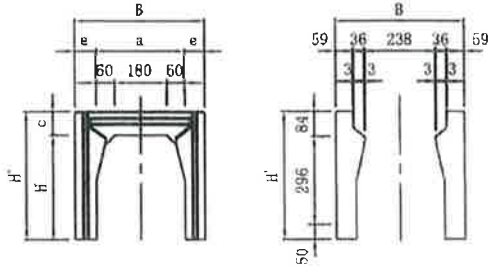

平面図

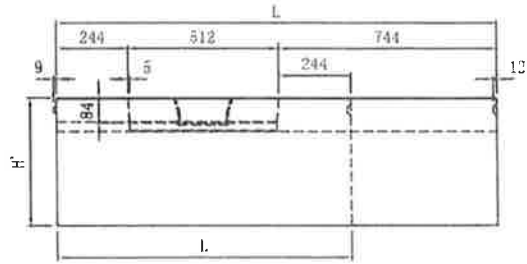

側面図

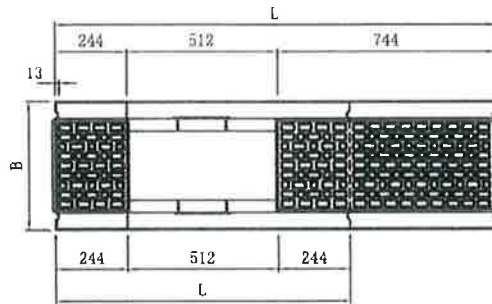

呼び	寸法 (mm)							参考重量					
	B	H'	a	H	e	c	L						
300×300	440	430	300	350	70	80	1000	186					
400		530		450				220					
500		630		550				253					
600		730		650				287					
700		830		750				320					
800		930		850				354					
900		1030		950				388					
1000		1130		1050				421					
1100		1230		1150				455					
1200		1330		1250				488					
300×300		440		430				300	350	70	80	1500	295
400				530					450				345
500	630		550	395									
600	730		650	446									
700	830		750	496									
800	930		850	547									
900	1030		950	597									
1000	1130		1050	647									
1100	1230		1150	698									
1200	1330		1250	748									

HS可変勾配側溝 (集水)

例 300×300

正面図

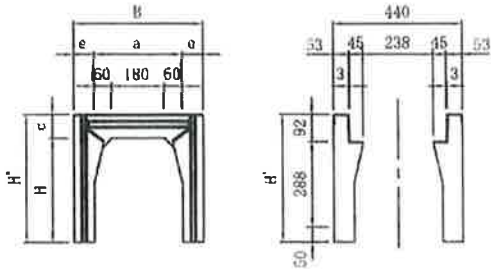

平面図

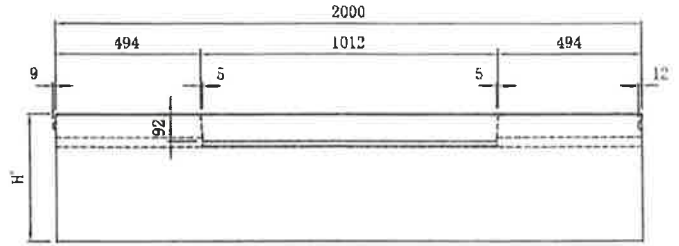

側面図

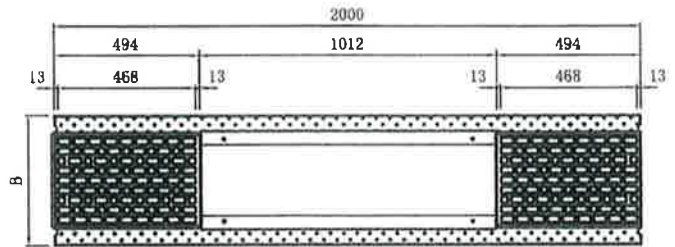

呼び	寸法 (mm)							参考重量
	B	H'	a	H	e	c	L	
300×300	440	430	300	350	70	80	2000	371
400		530		450				439
500		630		550				506
600		730		650				573
700		830		750				640
800		930		850				707
900		1030		950				775
1000		1130		1050				842
1100		1230		1150				909
1200		1330		1250				975

HS 可変勾配側溝

(集水 L=1500・1000)

例 300×300

正面図

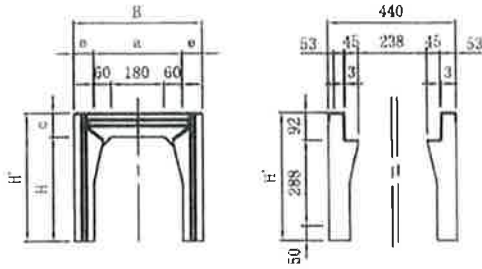

平面図

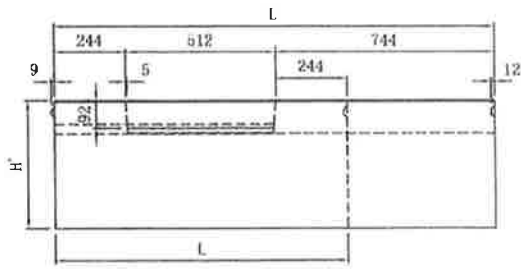

側面図

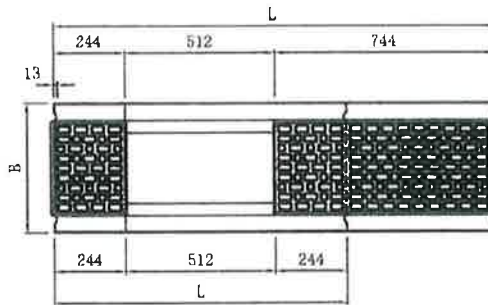

呼び	寸法 (mm)							参考重量					
	B	H'	a	H	e	c	L						
300×300	440	430	300	350	70	80	1000	186					
400		530		450				220					
500		630		550				253					
600		730		650				287					
700		830		750				320					
800		930		850				354					
900		1030		950				388					
1000		1130		1050				421					
1100		1230		1150				455					
1200		1330		1250				488					
300×300		440		430				300	350	70	80	1500	295
400				530					450				345
500	630		550	395									
600	730		650	446									
700	830		750	496									
800	930		850	547									
900	1030		950	597									
1000	1130		1050	647									
1100	1230		1150	698									
1200	1330		1250	748									

(株) 林建材

HS可変勾配側溝

例 400×400

正面図

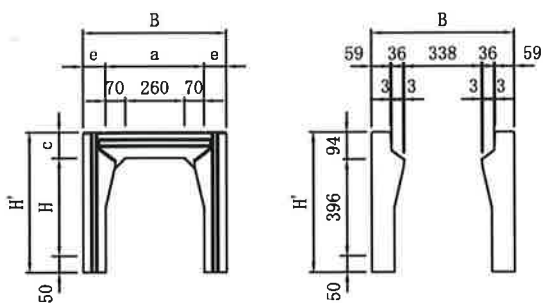

平面図

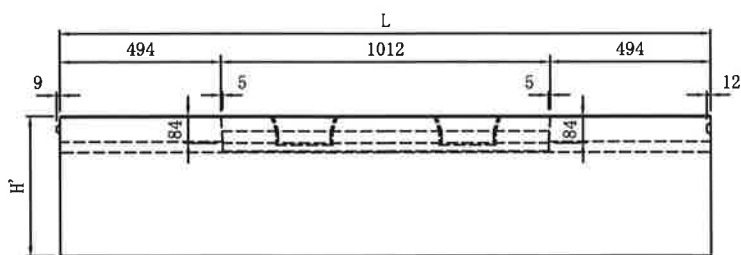

側面図

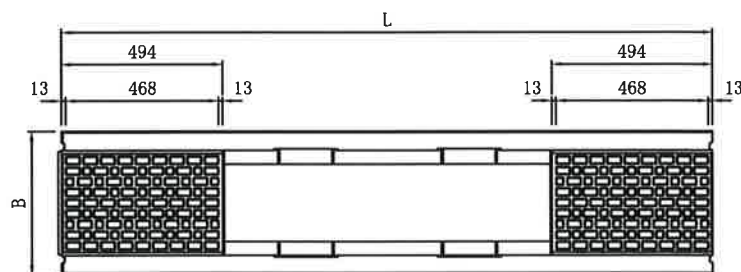

呼び	寸法 (mm)							参考重量
	B	H'	a	H	e	c	L	
400×400	540	540	400	400	70	90	2000	480
500		640		500				548
600		740		600				615
700		840		700				682
800		940		800				749
900		1040		900				816
1000		1140		1000				884

HS可変勾配側溝

(L=1500・1000)

例 400×400

正面図

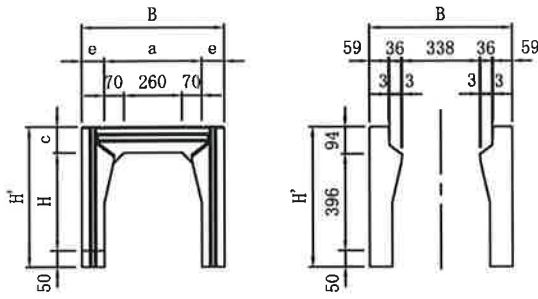

平面図

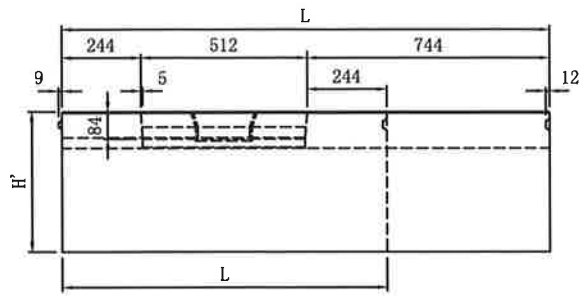

側面図

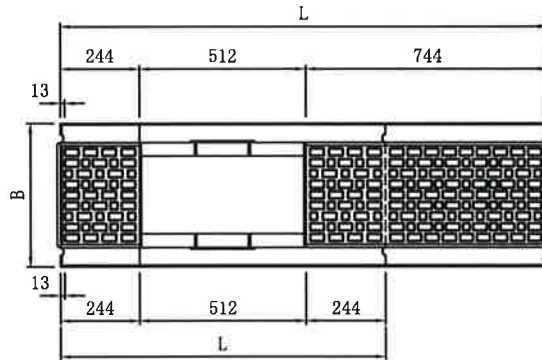

呼び	寸法 (mm)							参考重量			
	B	H'	a	H	e	c	L				
400×400	540	540	400	400	70	90	1000	240			
500		640		500				274			
600		740		600				308			
700		840		700				341			
800		940		800				375			
900		1040		900				408			
1000		1140		1000				442			
400×400		540		540				400	400	1500	383
500		640		500				500	434		
600		740		600				600	484		
700	840	700	700	535							
800	940	800	800	585							
900	1040	900	900	635							
1000	1140	1000	1000	686							