

# 千葉県型側溝

(標準)

(例：CH1-30-30)

CH1  
(歩道用)

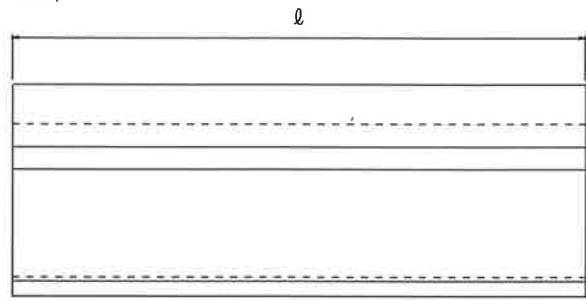
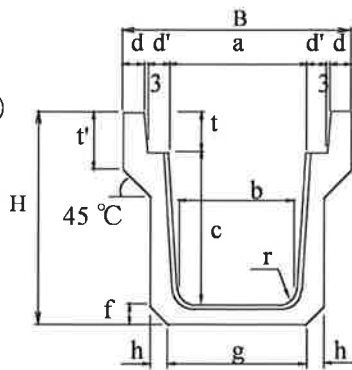

(例：CH25-30-30)

CH25  
(車道用)

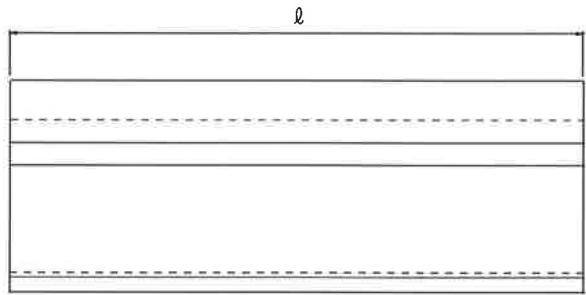
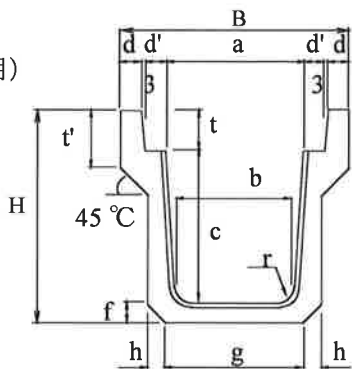

種類	呼び	寸法 (mm)															
		a	b	c	d	d'	e	f	g	h	t	t'	r	ℓ	B	H	参考重量
CH1	30-30	300	280	300	45	47	60	60	360	20	100	125	50	2000	490	460	342
	30-40	300	270	400	45	47	65	65	360	20	100	125	50	2000	490	565	414
	30-50	300	260	500	45	47	70	70	360	20	100	125	50	2000	490	670	491
	30-60	300	250	600	45	47	75	75	360	20	100	125	50	2000	490	775	572
	40-40	400	370	400	45	47	65	65	460	20	100	125	50	2000	590	565	445
	40-50	400	360	500	45	47	70	70	460	20	100	125	50	2000	590	670	524
	40-60	400	350	600	45	47	75	75	460	20	100	125	50	2000	590	775	608
CH25	30-30	300	280	300	55	47	70	70	360	30	100	145	50	2000	510	470	413
	30-40	300	270	400	55	47	75	75	340	40	100	145	50	2000	510	575	491
	30-50	300	260	500	55	47	80	80	340	40	100	145	50	2000	510	680	578
	30-60	300	250	600	55	47	85	85	340	40	100	145	50	2000	510	785	670
	40-40	400	370	400	60	47	70	70	430	40	100	140	50	2000	620	570	502
	40-50	400	360	500	60	47	80	80	440	40	100	140	50	2000	620	680	623
	40-60	400	350	600	60	47	85	85	440	40	100	140	50	2000	620	785	717

# 千葉県型側溝

(防音)

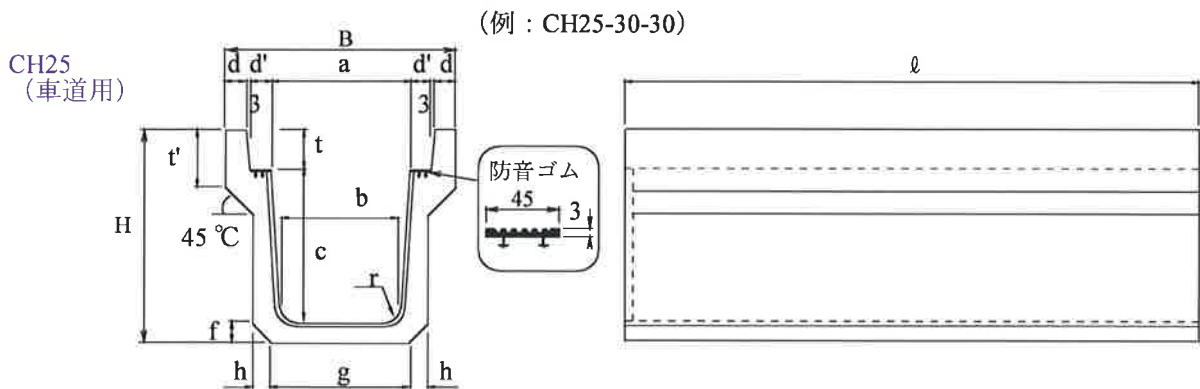
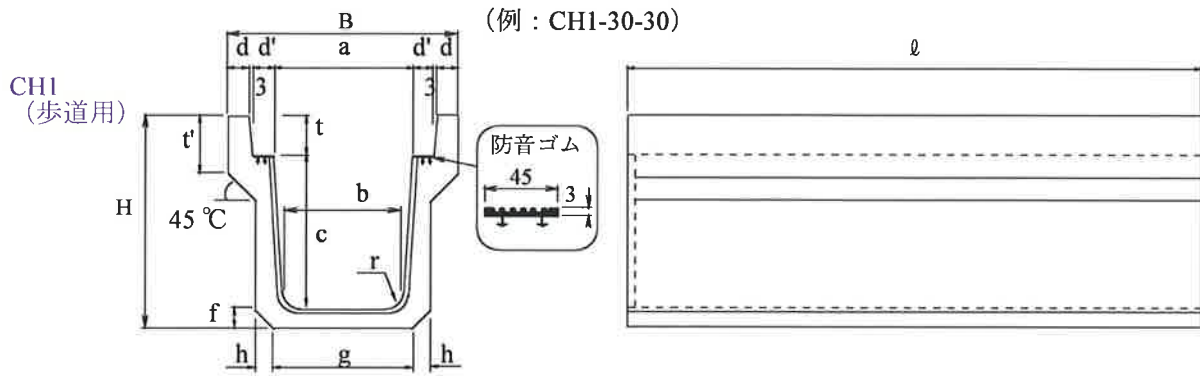

種類	呼び	寸法 (mm)															
		a	b	c	d	d'	e	f	g	h	t	t'	r	ℓ	B	H	参考重量
CH1	30-30	300	280	300	45	47	60	60	360	20	100	125	50	2000	490	460	342
	30-40	300	270	400	45	47	65	65	360	20	100	125	50	2000	490	565	414
	30-50	300	260	500	45	47	70	70	360	20	100	125	50	2000	490	670	491
	30-60	300	250	600	45	47	75	75	360	20	100	125	50	2000	490	775	572
	40-40	400	370	400	45	47	65	65	460	20	100	125	50	2000	590	565	445
	40-50	400	360	500	45	47	70	70	460	20	100	125	50	2000	590	670	524
	40-60	400	350	600	45	47	75	75	460	20	100	125	50	2000	590	775	608
CH25	30-30	300	280	300	55	47	70	70	360	30	100	145	50	2000	510	470	413
	30-40	300	270	400	55	47	75	75	340	40	100	145	50	2000	510	575	491
	30-50	300	260	500	55	47	80	80	340	40	100	145	50	2000	510	680	578
	30-60	300	250	600	55	47	85	85	340	40	100	145	50	2000	510	785	670
	40-40	400	370	400	60	47	70	70	430	40	100	140	50	2000	620	570	502
	40-50	400	360	500	60	47	80	80	440	40	100	140	50	2000	620	680	623
	40-60	400	350	600	60	47	85	85	440	40	100	140	50	2000	620	785	717

# 千葉県型側溝

(集水)

(例：CH25-30-30)

CH25  
(車道用)

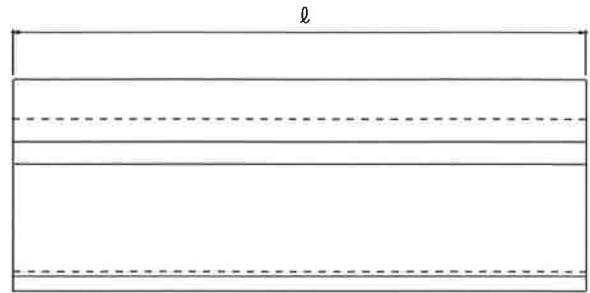
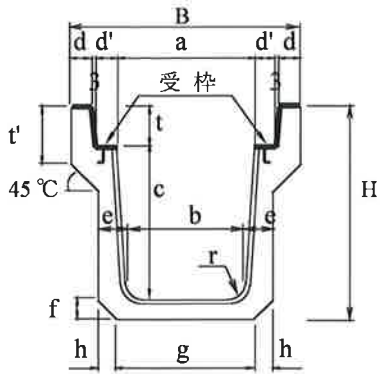

(例：CH25-40-40)

CH25  
(車道用)

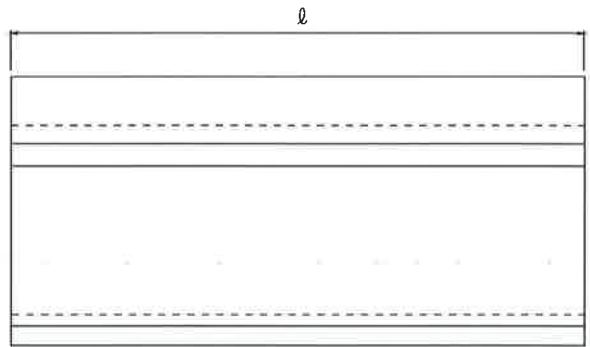
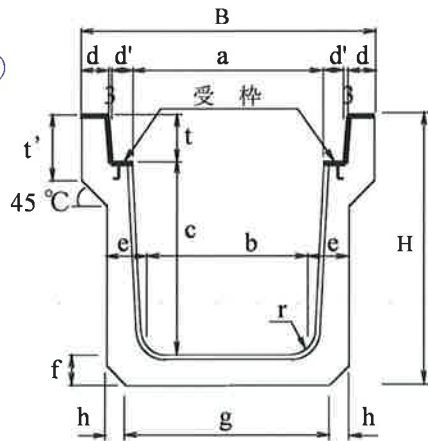

種類	呼び	寸法 (mm)															
		a	b	c	d	d'	e	f	g	h	t	t'	r	ℓ	B	H	参考重量
CH25	30-30	300	280	300	55	47	70	70	360	30	100	145	50	2000	510	470	413
	30-40	300	270	400	55	47	75	75	340	40	100	145	50	2000	510	575	491
	30-50	300	260	500	55	47	80	80	340	40	100	145	50	2000	510	680	578
	30-60	300	250	600	55	47	85	85	340	40	100	145	50	2000	510	785	670
	40-40	400	370	400	60	47	70	70	430	40	100	140	50	2000	620	570	502
	40-50	400	360	500	60	47	80	80	440	40	100	140	50	2000	620	680	623
	40-60	400	350	600	60	47	85	85	440	40	100	140	50	2000	620	785	717

# 千葉県型側溝

(標準排水ドレソ金具仕様)

CH1 (歩道用) (例: CH1-30-30)

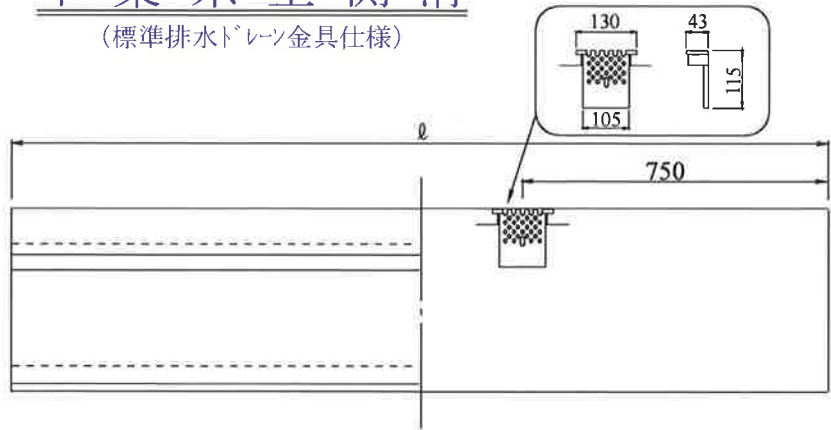
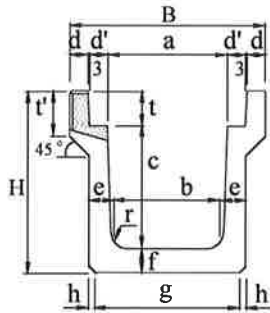

CH25 (車道用) (例: CH25-30-30)

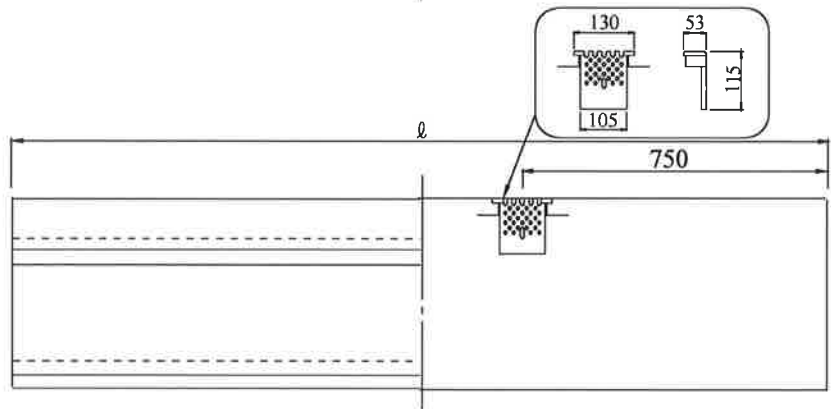
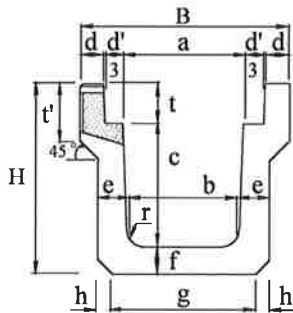

種類	呼び	寸法 (mm)															
		a	b	c	d	d'	e	f	g	h	t	t'	r	ℓ	B	H	参考重量
CH1	30-30	300	280	300	45	47	60	60	360	20	100	125	50	2000	490	460	342
	30-40	300	270	400	45	47	65	65	360	20	100	125	50	2000	490	565	414
	30-50	300	260	500	45	47	70	70	360	20	100	125	50	2000	490	670	491
	30-60	300	250	600	45	47	75	75	360	20	100	125	50	2000	490	775	572
	40-40	400	370	400	45	47	65	65	460	20	100	125	50	2000	590	565	445
	40-50	400	360	500	45	47	70	70	460	20	100	125	50	2000	590	670	524
	40-60	400	350	600	45	47	75	75	460	20	100	125	50	2000	590	775	608
CH25	30-30	300	280	300	55	47	70	70	360	30	100	145	50	2000	510	470	413
	30-40	300	270	400	55	47	75	75	340	40	100	145	50	2000	510	575	491
	30-50	300	260	500	55	47	80	80	340	40	100	145	50	2000	510	680	578
	30-60	300	250	600	55	47	85	85	340	40	100	145	50	2000	510	785	670
	40-40	400	370	400	60	47	70	70	430	40	100	140	50	2000	620	570	502
	40-50	400	360	500	60	47	80	80	440	40	100	140	50	2000	620	680	623
	40-60	400	350	600	60	47	85	85	440	40	100	140	50	2000	620	785	717

# 千葉県型側溝ふた

CHL25-30 重量 46kg

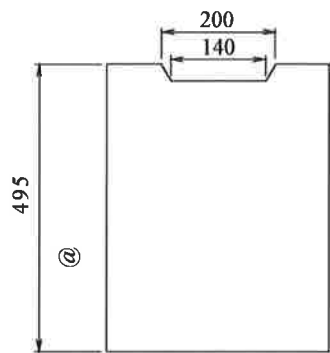
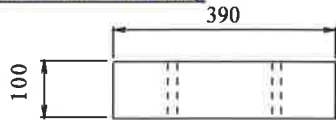

CHL25-40 重量 67kg

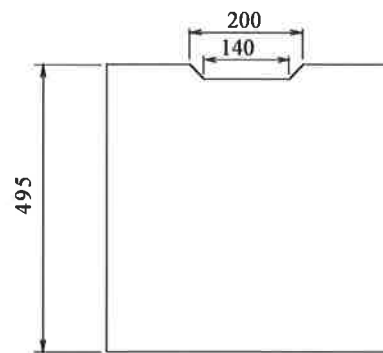
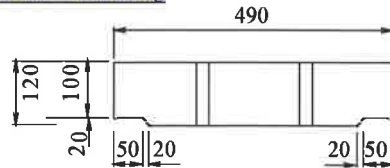

CHL1-30 重量 37kg

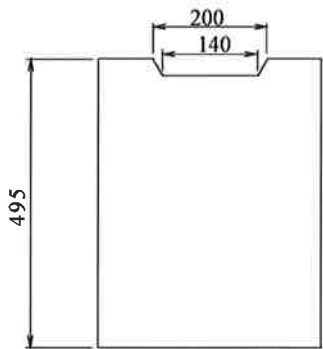
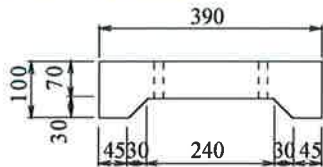

CHL1-40 重量 46kg

