

# ソケット U T-25

(標準)

例 240 × 300 × 2000

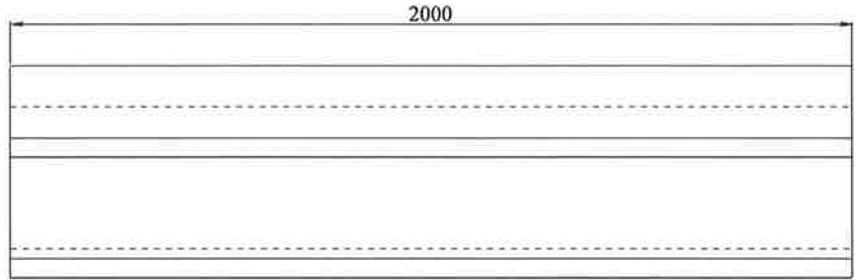
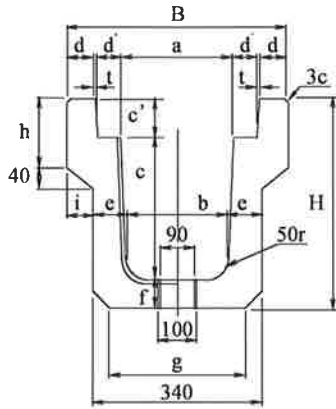

呼び	寸法 (mm)															参考重量
	a	b	c	c'	d	d'	t	e	f	g	h	i	r	B	H	
240 × 240 × 2000	240	220	240	85	58	50	2	60	60	280	145	60	50	460	385	320
240 × 300 × 2000	"	"	300	"	"	"	"	"	"	"	"	"	"	460	445	347
240 × 400 × 2000	"	200	400	"	"	"	"	70	65	"	"	"	"	460	550	427
240 × 500 × 2000	"	190	500	"	"	"	"	75	70	"	"	"	"	460	655	505
240 × 600 × 2000	"	180	600	"	"	"	"	80	75	"	"	"	"	460	760	587
240 × 700 × 2000	"	170	700	"	"	"	"	85	80	400	"	"	"	460	865	695

240 × 700 × 2000 T-25 参考重量 695kg

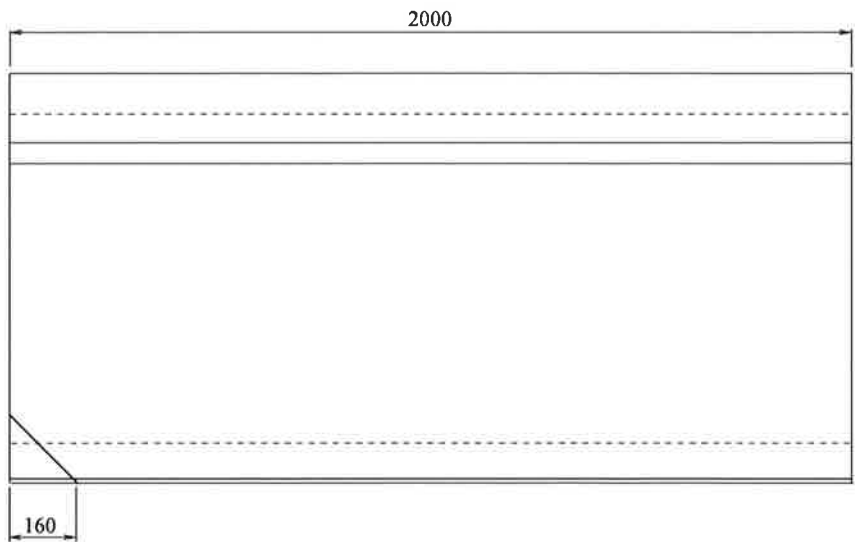
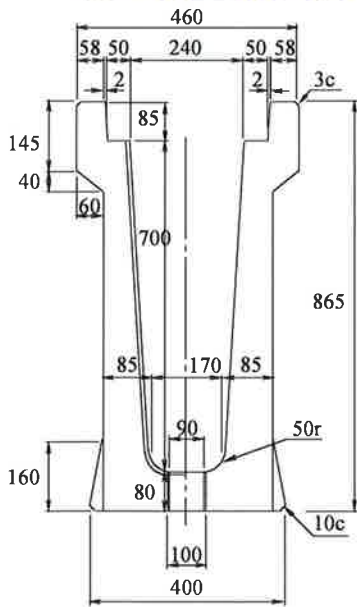

# ソケット U T-25 (防音)

例 240 × 300 × 2000

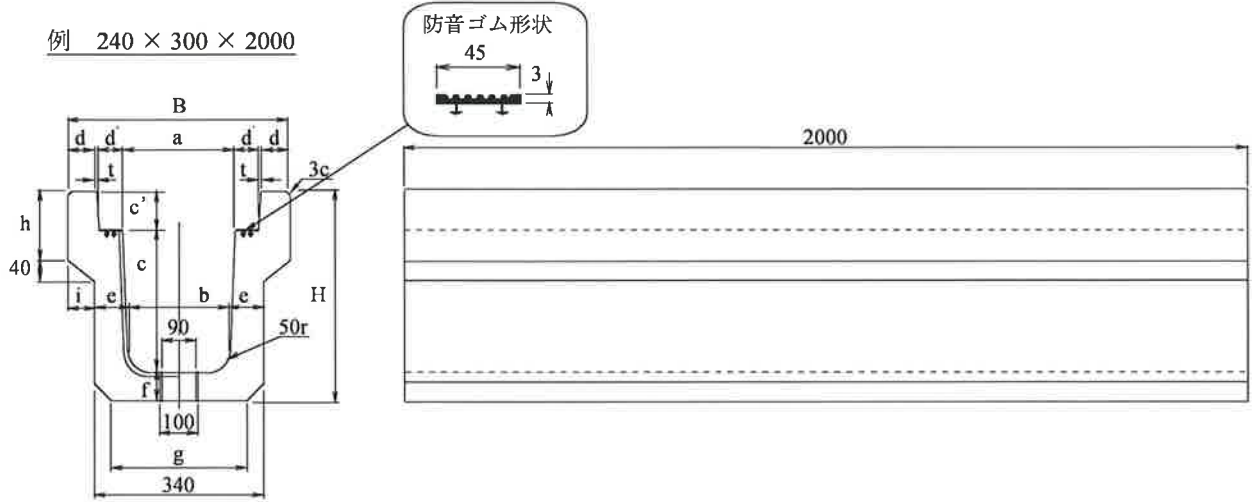

呼 び	寸 法 (mm)														参考重量	
	a	b	c	c'	d	d'	t	e	f	g	h	i	r	B		H
240 × 240 × 2000	240	220	240	85	58	50	2	60	60	280	145	60	50	460	385	320
240 × 300 × 2000	〃	〃	300	〃	〃	〃	〃	〃	〃	〃	〃	〃	〃	460	445	347
240 × 400 × 2000	〃	200	400	〃	〃	〃	〃	70	65	〃	〃	〃	〃	460	550	427
240 × 500 × 2000	〃	190	500	〃	〃	〃	〃	75	70	〃	〃	〃	〃	460	655	505
240 × 600 × 2000	〃	180	600	〃	〃	〃	〃	80	75	〃	〃	〃	〃	460	760	587
240 × 700 × 2000	〃	170	700	〃	〃	〃	〃	85	80	400	〃	〃	〃	460	865	695

240 × 700 × 2000 T-25

参考重量 695kg

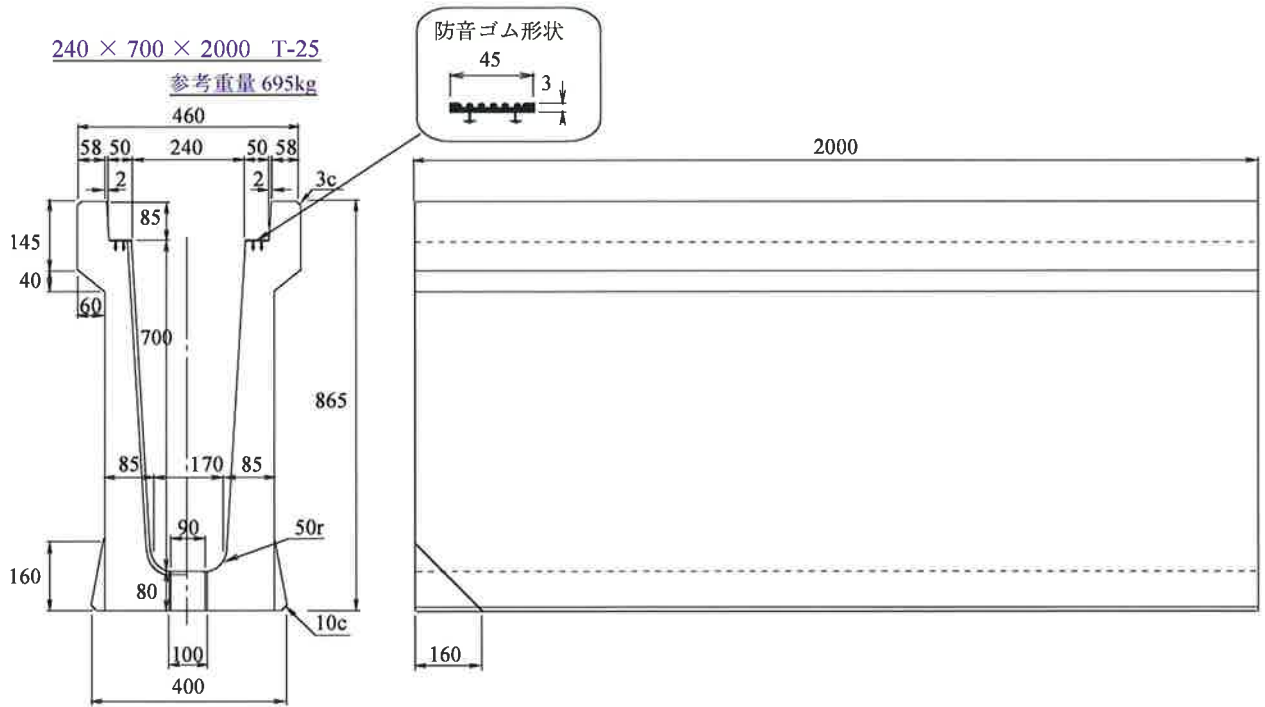

# ソケット U T-25 (集水)

例 240 × 300 × 2000

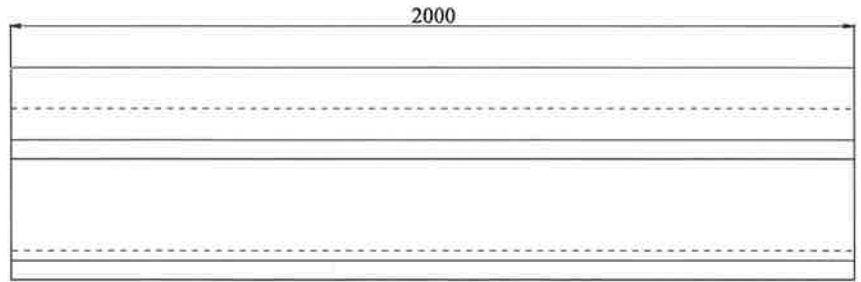
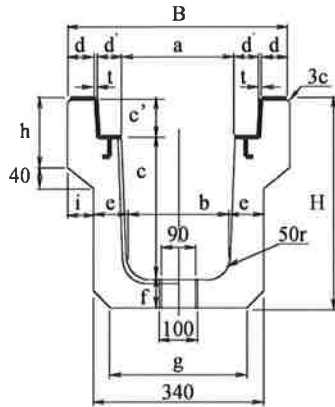

呼び	寸法 (mm)															参考重量
	a	b	c	c'	d	d'	t	e	f	g	h	i	r	B	H	
240 × 240 × 2000	240	220	240	85	58	50	2	60	60	280	145	60	50	460	385	320
240 × 300 × 2000	〃	〃	300	〃	〃	〃	〃	〃	〃	〃	〃	〃	〃	460	445	347
240 × 400 × 2000	〃	200	400	〃	〃	〃	〃	70	65	〃	〃	〃	〃	460	550	427
240 × 500 × 2000	〃	190	500	〃	〃	〃	〃	75	70	〃	〃	〃	〃	460	655	505
240 × 600 × 2000	〃	180	600	〃	〃	〃	〃	80	75	〃	〃	〃	〃	460	760	587
240 × 700 × 2000	〃	170	700	〃	〃	〃	〃	85	80	400	〃	〃	〃	460	865	695

240 × 700 × 2000 T-25 参考重量 695kg

